

Zoom Lens

This lens is designed for use with Panasonic’s applicable projectors. With ultra-short throw-distance and flexible zoom, this lens is designed to project in extremely tight spaces., with minimal screen shadowing.

NOTE: Please use the lens only on the specified Panasonic projector.

Specifications

F value:	2.0
Focal distance (f):	4.1-4.4 mm (5/32-11/64 inches)
Throw ratio:	0.280-0.299:1 for PT-RCQ10/RCQ80/RZ120/RZ970/RZ870/RZ770/ RZ660 (16:10 aspect ratio) 0.294-0.314:1 for PT-RW930/RW730/RW620 (16:10 aspect ratio) 0.290-0.309:1 for PT-RX110 (4:3 aspect)
Dimensions (W × H × D):	170 × 170 × 391 mm (6-11/16 × 6-11/16 × 15-13/32 inches)
Weight:	Approximately 3.2 kg* (7.05 lbs*)
Applicable projector	PT-RCQ10/RCQ80/RZ120/RZ970/RW930/RX110/RZ870/RZ770/RW730/ RZ660/RW620

Supplied Accessories

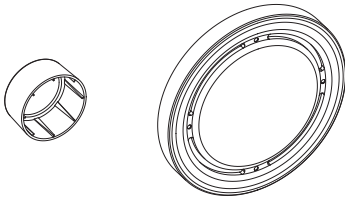
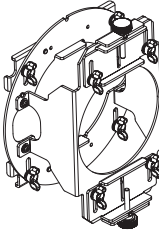
Lens cover	Lens fixed attachment
 <p>1 each</p>	 <p>x 1</p>

*this lens must be used with the supplied lens fixed attachment.

Dimensions

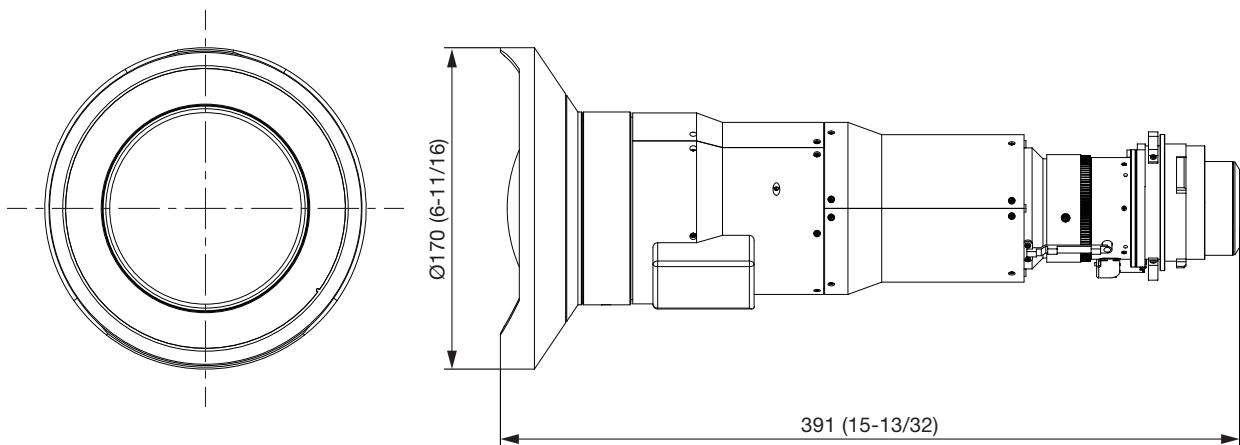

unit : mm (inch)

NOTE: This illustration is not drawn to scale.

NOTE: Weights and dimensions shown are approximate. Specifications subject to change without notice.

PT-RCQ10/RCQ80/RZ120/RZ970/RW930/RX110/RZ870/RZ770/RW730/RZ660/RW620

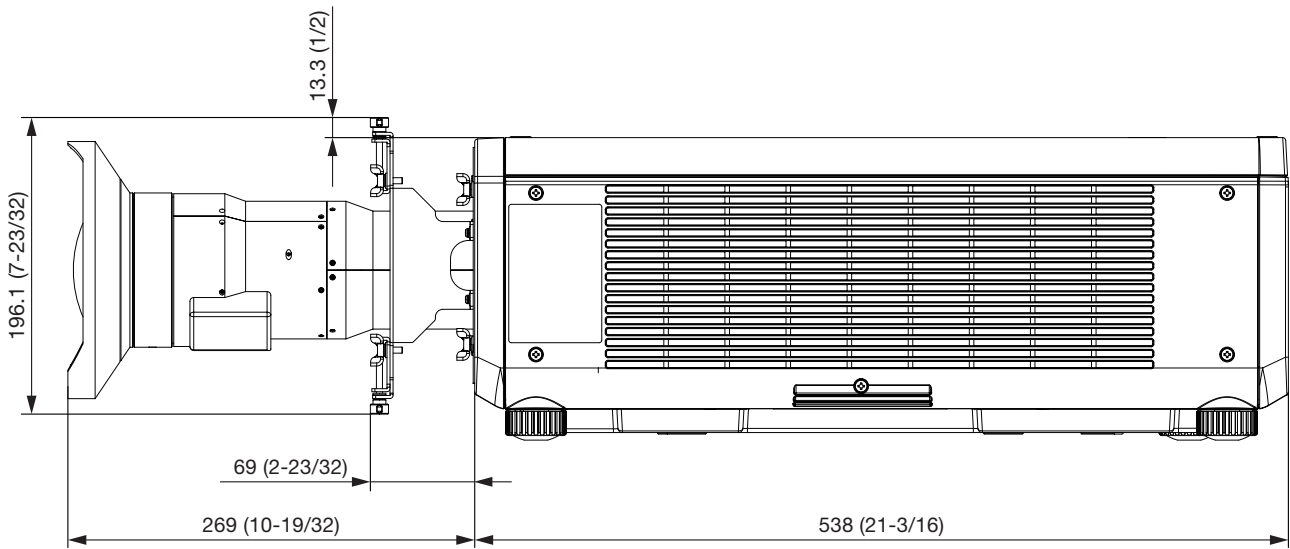

unit : mm (inch)

NOTE: This illustration is not drawn to scale.

NOTE: Weights and dimensions shown are approximate. Specifications subject to change without notice.

Zoom Lens

Dimensional relationship diagram

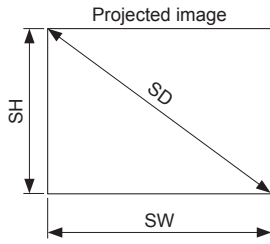

NOTE

- This diagram assumes that the size and position of the projected image will be adjusted so that the image fills the entire screen.
- This illustration is not drawn to scale.

L		Projection distance
	LW	Minimum distance
	LT	Maximum distance
L1		Lens protrusion dimension
SH		Image height
H		Distance from the lens center to the lower edge of the projected image
SW		Image width
SD		Projected image size

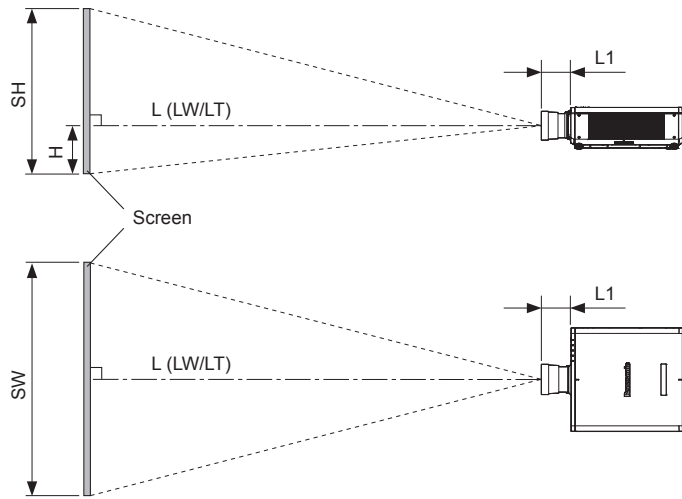

(unit: meters)

Projector model	Dimension for L1 (approximate value)
PT-RCQ10/RCQ80/RZ120/RZ970/RW930/RX110/RZ870/RZ770/RW730/RZ660/RW620	0.269

Projection distance

PT-RCQ10/RCQ80/RZ120/RZ970/RZ870/RZ770/RZ660
Aspect ratio 16:10

unit: meters (feet)

Projection size (Diagonal) [SD]	Projection size (Height) [SH]	Projection size (Width) [SW]	Projection distance Throw ratio[0.280-0.299:1] [L]		Height from the edge of screen to center of lens [H]
			Min [LW]	Max [LT]	
2.540 m / 100"	1.346 (4.42)	2.154 (7.07)	0.59 (1.94)	0.64 (2.10)	0.00~0.89 (0.00~ 2.92)
3.048 m / 120"	1.615 (5.30)	2.585 (8.48)	0.72 (2.36)	0.77 (2.53)	0.00~1.07 (0.00~ 3.51)
3.810 m / 150"	2.019 (6.62)	3.231 (10.60)	0.90 (2.95)	0.97 (3.18)	0.00~1.33 (0.00~ 4.36)
5.080 m / 200"	2.692 (8.83)	4.308 (14.13)	1.21 (3.97)	1.30 (4.27)	0.00~1.78 (0.00~ 5.84)
6.350 m / 250"	3.365 (11.04)	5.385 (17.67)	1.52 (4.99)	1.63 (5.35)	0.00~2.22 (0.00~ 7.28)
7.620 m / 300"	4.039 (13.25)	6.462 (21.20)	1.83 (6.00)	1.96 (6.43)	0.00~2.67 (0.00~ 8.76)
8.890 m / 350"	4.712 (15.46)	7.539 (24.73)	2.14 (7.02)	2.29 (7.51)	0.00~3.11 (0.00~10.20)
10.160 m / 400"	5.385 (17.67)	8.616 (28.27)	2.45 (8.04)	2.63 (8.63)	0.00~3.55 (0.00~11.65)

PT-RW930/RW730/RW620
Aspect ratio 16:10

unit: meters (feet)

Projection size (Diagonal) [SD]	Projection size (Height) [SH]	Projection size (Width) [SW]	Projection distance Throw ratio[0.294-0.314:1] [L]		Height from the edge of screen to center of lens [H]
			Min [LW]	Max [LT]	
2.540 m / 100"	1.346 (4.42)	2.154 (7.07)	0.62 (2.03)	0.67 (2.20)	-0.07~1.17 (-0.23~ 3.84)
3.048 m / 120"	1.615 (5.30)	2.585 (8.48)	0.75 (2.46)	0.81 (2.66)	-0.08~1.41 (-0.26~ 4.63)
3.810 m / 150"	2.019 (6.62)	3.231 (10.60)	0.95 (3.12)	1.02 (3.35)	-0.10~1.76 (-0.33~ 5.77)
5.080 m / 200"	2.692 (8.83)	4.308 (14.13)	1.27 (4.17)	1.37 (4.49)	-0.13~2.34 (-0.43~ 7.68)
6.350 m / 250"	3.365 (11.04)	5.385 (17.67)	1.60 (5.25)	1.71 (5.61)	-0.17~2.93 (-0.56~ 9.61)
7.620 m / 300"	4.039 (13.25)	6.462 (21.20)	1.92 (6.30)	2.06 (6.76)	-0.20~3.51 (-0.66~11.52)
8.890 m / 350"	4.712 (15.46)	7.539 (24.73)	2.25 (7.38)	2.41 (7.91)	-0.24~4.10 (-0.79~13.45)
10.160 m / 400"	5.385 (17.67)	8.616 (28.27)	2.57 (8.43)	2.76 (9.06)	-0.27~4.68 (-0.89~15.35)

Zoom Lens

PT-RCQ10/RCQ80/RZ120/RZ970/RZ870/RZ770/RZ660

Aspect ratio 16:9

unit: meters (feet)

Projection size (Diagonal)	Projection size (Height)	Projection size (Width)	Projection distance Throw ratio[0.280-0.299:1]		Height from the edge of screen to center of lens
			[L]		
[SD]	[SH]	[SW]	Min [LW]	Max [LT]	[H]
2.540 m / 100"	1.245 (4.08)	2.214 (7.26)	0.61 (2.00)	0.65 (2.13)	-0.12~0.91 (-0.39~ 2.99)
3.048 m / 120"	1.494 (4.90)	2.657 (8.72)	0.74 (2.43)	0.79 (2.59)	-0.15~1.10 (-0.49~ 3.61)
3.810 m / 150"	1.868 (6.13)	3.321 (10.90)	0.93 (3.05)	0.99 (3.25)	-0.19~1.37 (-0.62~ 4.49)
5.080 m / 200"	2.491 (8.17)	4.428 (14.53)	1.25 (4.10)	1.34 (4.40)	-0.25~1.83 (-0.82~ 6.00)
6.350 m / 250"	3.113 (10.21)	5.535 (18.16)	1.56 (5.12)	1.68 (5.51)	-0.31~2.28 (-1.02~ 7.48)
7.620 m / 300"	3.736 (12.26)	6.641 (21.79)	1.88 (6.17)	2.02 (6.63)	-0.37~2.74 (-1.21~ 8.99)
8.890 m / 350"	4.358 (14.30)	7.748 (25.42)	2.20 (7.22)	2.36 (7.74)	-0.44~3.20 (-1.44~10.50)
10.160 m / 400"	4.981 (16.34)	8.855 (29.05)	2.52 (8.27)	2.70 (8.86)	-0.50~3.65 (-1.64~11.97)

PT-RW930/RW730/RW620

Aspect ratio 16:9

unit: meters (feet)

Projection size (Diagonal)	Projection size (Height)	Projection size (Width)	Projection distance Throw ratio[0.294-0.314:1]		Height from the edge of screen to center of lens
			[L]		
[SD]	[SH]	[SW]	Min [LW]	Max [LT]	[H]
2.540 m / 100"	1.245 (4.08)	2.214 (7.26)	0.64 (2.10)	0.69 (2.26)	-0.21~1.20 (-0.69~ 3.94)
3.048 m / 120"	1.494 (4.90)	2.657 (8.72)	0.78 (2.56)	0.83 (2.72)	-0.25~1.44 (-0.82~ 4.72)
3.810 m / 150"	1.868 (6.13)	3.321 (10.90)	0.98 (3.22)	1.05 (3.44)	-0.31~1.81 (-1.02~ 5.94)
5.080 m / 200"	2.491 (8.17)	4.428 (14.53)	1.31 (4.30)	1.40 (4.59)	-0.42~2.41 (-1.38~ 7.91)
6.350 m / 250"	3.113 (10.21)	5.535 (18.16)	1.64 (5.38)	1.76 (5.77)	-0.52~3.01 (-1.71~ 9.88)
7.620 m / 300"	3.736 (12.26)	6.641 (21.79)	1.98 (6.50)	2.12 (6.96)	-0.62~3.61 (-2.03~11.84)
8.890 m / 350"	4.358 (14.30)	7.748 (25.42)	2.31 (7.58)	2.48 (8.14)	-0.73~4.21 (-2.39~13.81)
10.160 m / 400"	4.981 (16.34)	8.855 (29.05)	2.65 (8.69)	2.84 (9.32)	-0.83~4.82 (-2.72~15.81)

PT-RX110

Aspect ratio 16:9

unit: meters (feet)

Projection size (Diagonal)	Projection size (Height)	Projection size (Width)	Projection distance Throw ratio[0.290-0.310:1]		Height from the edge of screen to center of lens
			[L]		
[SD]	[SH]	[SW]	Min [LW]	Max [LT]	[H]
2.540 m / 100"	1.245 (4.08)	2.214 (7.26)	0.63 (2.07)	0.68 (2.23)	0.22~1.25 (0.72~ 4.10)
3.048 m / 120"	1.494 (4.90)	2.657 (8.72)	0.76 (2.49)	0.82 (2.69)	0.26~1.49 (0.85~ 4.89)
3.810 m / 150"	1.868 (6.13)	3.321 (10.90)	0.96 (3.15)	1.03 (3.38)	0.32~1.87 (1.05~ 6.14)
5.080 m / 200"	2.491 (8.17)	4.428 (14.53)	1.29 (4.23)	1.39 (4.56)	0.43~2.49 (1.41~ 8.17)
6.350 m / 250"	3.113 (10.21)	5.535 (18.16)	1.62 (5.31)	1.74 (5.71)	0.54~3.11 (1.77~10.20)
7.620 m / 300"	3.736 (12.26)	6.641 (21.79)	1.95 (6.40)	2.09 (6.86)	0.65~3.74 (2.13~12.27)
8.890 m / 350"	4.358 (14.30)	7.748 (25.42)	2.28 (7.48)	2.44 (8.01)	0.76~4.36 (2.49~14.30)
10.160 m / 400"	4.981 (16.34)	8.855 (29.05)	2.61 (8.56)	2.80 (9.19)	0.86~4.98 (2.82~16.34)

Zoom Lens

PT-RCQ10/RCQ80/RZ120/RZ970/RZ870/RZ770/RZ660

Aspect ratio 4:3

unit: meters (feet)

Projection size (Diagonal)	Projection size (Height)	Projection size (Width)	Projection distance Throw ratio[0.337-0.360:1]		Height from the edge of screen to center of lens
			[SD]	[SH]	
2.540 m / 100°	1.524 (5.00)	2.032 (6.67)	0.67 (2.20)	0.72 (2.36)	0.00~1.01 (0.00~ 3.31)
3.048 m / 120°	1.829 (6.00)	2.438 (8.00)	0.81 (2.66)	0.87 (2.85)	0.00~1.21 (0.00~ 3.97)
3.810 m / 150°	2.286 (7.50)	3.048 (10.00)	1.03 (3.38)	1.10 (3.61)	0.00~1.51 (0.00~ 4.95)
5.080 m / 200°	3.048 (10.00)	4.064 (13.33)	1.38 (4.53)	1.47 (4.82)	0.00~2.01 (0.00~ 6.59)
6.350 m / 250°	3.810 (12.50)	5.080 (16.67)	1.73 (5.68)	1.85 (6.07)	0.00~2.51 (0.00~ 8.23)
7.620 m / 300°	4.572 (15.00)	6.096 (20.00)	2.08 (6.82)	2.23 (7.32)	0.00~3.02 (0.00~ 9.91)
8.890 m / 350°	5.334 (17.50)	7.112 (23.33)	2.43 (7.97)	2.60 (8.53)	0.00~3.52 (0.00~11.55)
10.160 m / 400°	6.096 (20.00)	8.128 (26.67)	2.78 (9.12)	2.98 (9.78)	0.00~4.02 (0.00~13.19)

PT-RW930/RW730/RW620

Aspect ratio 4:3

unit: meters (feet)

Projection size (Diagonal)	Projection size (Height)	Projection size (Width)	Projection distance Throw ratio[0.354-0.378:1]		Height from the edge of screen to center of lens
			[SD]	[SH]	
2.540 m / 100°	1.524 (5.00)	2.032 (6.67)	0.71 (2.33)	0.76 (2.49)	-0.08~1.33 (-0.26~ 4.36)
3.048 m / 120°	1.829 (6.00)	2.438 (8.00)	0.86 (2.82)	0.92 (3.02)	-0.09~1.59 (-0.30~ 5.22)
3.810 m / 150°	2.286 (7.50)	3.048 (10.00)	1.08 (3.54)	1.15 (3.77)	-0.11~1.99 (-0.36~ 6.53)
5.080 m / 200°	3.048 (10.00)	4.064 (13.33)	1.44 (4.72)	1.55 (5.09)	-0.15~2.65 (-0.49~ 8.69)
6.350 m / 250°	3.810 (12.50)	5.080 (16.67)	1.81 (5.94)	1.94 (6.36)	-0.19~3.31 (-0.62~10.86)
7.620 m / 300°	4.572 (15.00)	6.096 (20.00)	2.18 (7.15)	2.34 (7.68)	-0.23~3.98 (-0.75~13.06)
8.890 m / 350°	5.334 (17.50)	7.112 (23.33)	2.55 (8.37)	2.73 (8.96)	-0.27~4.64 (-0.89~15.22)
10.160 m / 400°	6.096 (20.00)	8.128 (26.67)	2.92 (9.58)	3.12 (10.24)	-0.30~5.30 (-0.98~17.39)

PT-RX110

Aspect ratio 4:3

unit: meters (feet)

Projection size (Diagonal)	Projection size (Height)	Projection size (Width)	Projection distance Throw ratio[0.290-0.309:1]		Height from the edge of screen to center of lens
			[SD]	[SH]	
2.540 m / 100°	1.524 (5.00)	2.032 (6.67)	0.58 (1.90)	0.62 (2.03)	0.18~1.14 (0.59~ 3.74)
3.048 m / 120°	1.829 (6.00)	2.438 (8.00)	0.70 (2.30)	0.75 (2.46)	0.22~1.37 (0.72~ 4.49)
3.810 m / 150°	2.286 (7.50)	3.048 (10.00)	0.88 (2.89)	0.94 (3.08)	0.27~1.71 (0.89~ 5.61)
5.080 m / 200°	3.048 (10.00)	4.064 (13.33)	1.18 (3.87)	1.27 (4.17)	0.37~2.29 (1.21~ 7.51)
6.350 m / 250°	3.810 (12.50)	5.080 (16.67)	1.49 (4.89)	1.59 (5.22)	0.46~2.86 (1.51~ 9.38)
7.620 m / 300°	4.572 (15.00)	6.096 (20.00)	1.79 (5.87)	1.92 (6.30)	0.55~3.43 (1.80~11.25)
8.890 m / 350°	5.334 (17.50)	7.112 (23.33)	2.09 (6.86)	2.24 (7.35)	0.64~4.00 (2.10~13.12)
10.160 m / 400°	6.096 (20.00)	8.128 (26.67)	2.39 (7.84)	2.57 (8.43)	0.73~4.57 (2.39~14.99)

Zoom Lens

Calculation of the projection distance

Aspect ratio 16:10

unit: meters

PT-RCQ10/RCQ80/RZ120/RZ970/ RZ870/RZ770/RZ660	minimum	$LW (m) = (\text{diagonal screen size in inches}) \times 0.0062 - 0.0266$
	maximum	$LT (m) = (\text{diagonal screen size in inches}) \times 0.0066 - 0.0279$
PT-RW930/RW730/RW620	minimum	$LW (m) = (\text{diagonal screen size in inches}) \times 0.0065 - 0.0266$
	maximum	$LT (m) = (\text{diagonal screen size in inches}) \times 0.0070 - 0.0279$

Aspect ratio 16:9

unit: meters

PT-RCQ10/RCQ80/RZ120/RZ970/ RZ870/RZ770/RZ660	minimum	$LW (m) = (\text{diagonal screen size in inches}) \times 0.0064 - 0.0266$
	maximum	$LT (m) = (\text{diagonal screen size in inches}) \times 0.0068 - 0.0279$
PT-RW930/RW730/RW620	minimum	$LW (m) = (\text{diagonal screen size in inches}) \times 0.0067 - 0.0266$
	maximum	$LT (m) = (\text{diagonal screen size in inches}) \times 0.0072 - 0.0279$
PT-RX110	minimum	$LW (m) = (\text{diagonal screen size in inches}) \times 0.0066 - 0.0266$
	maximum	$LT (m) = (\text{diagonal screen size in inches}) \times 0.0071 - 0.0279$

Aspect ratio 4:3

unit: meters

PT-RCQ10/RCQ80/RZ120/RZ970/ RZ870/RZ770/RZ660	minimum	$LW (m) = (\text{diagonal screen size in inches}) \times 0.0070 - 0.0266$
	maximum	$LT (m) = (\text{diagonal screen size in inches}) \times 0.0075 - 0.0279$
PT-RW930/RW730/RW620	minimum	$LW (m) = (\text{diagonal screen size in inches}) \times 0.0074 - 0.0266$
	maximum	$LT (m) = (\text{diagonal screen size in inches}) \times 0.0079 - 0.0279$
PT-RX110	minimum	$LW (m) = (\text{diagonal screen size in inches}) \times 0.0061 - 0.0266$
	maximum	$LT (m) = (\text{diagonal screen size in inches}) \times 0.0065 - 0.0279$

Shift range

Optical axis shift function allows to shift the position of a projected image as shown below.

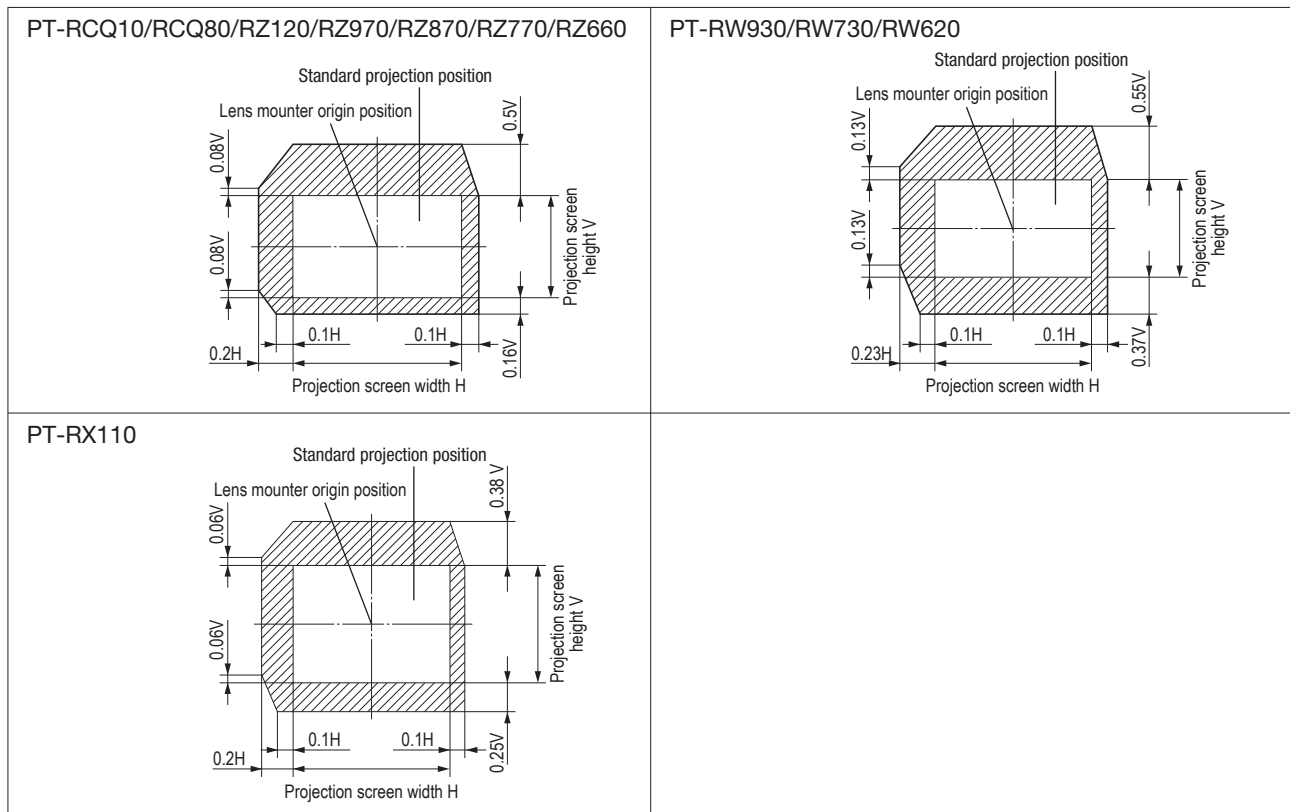

Keystone correction range

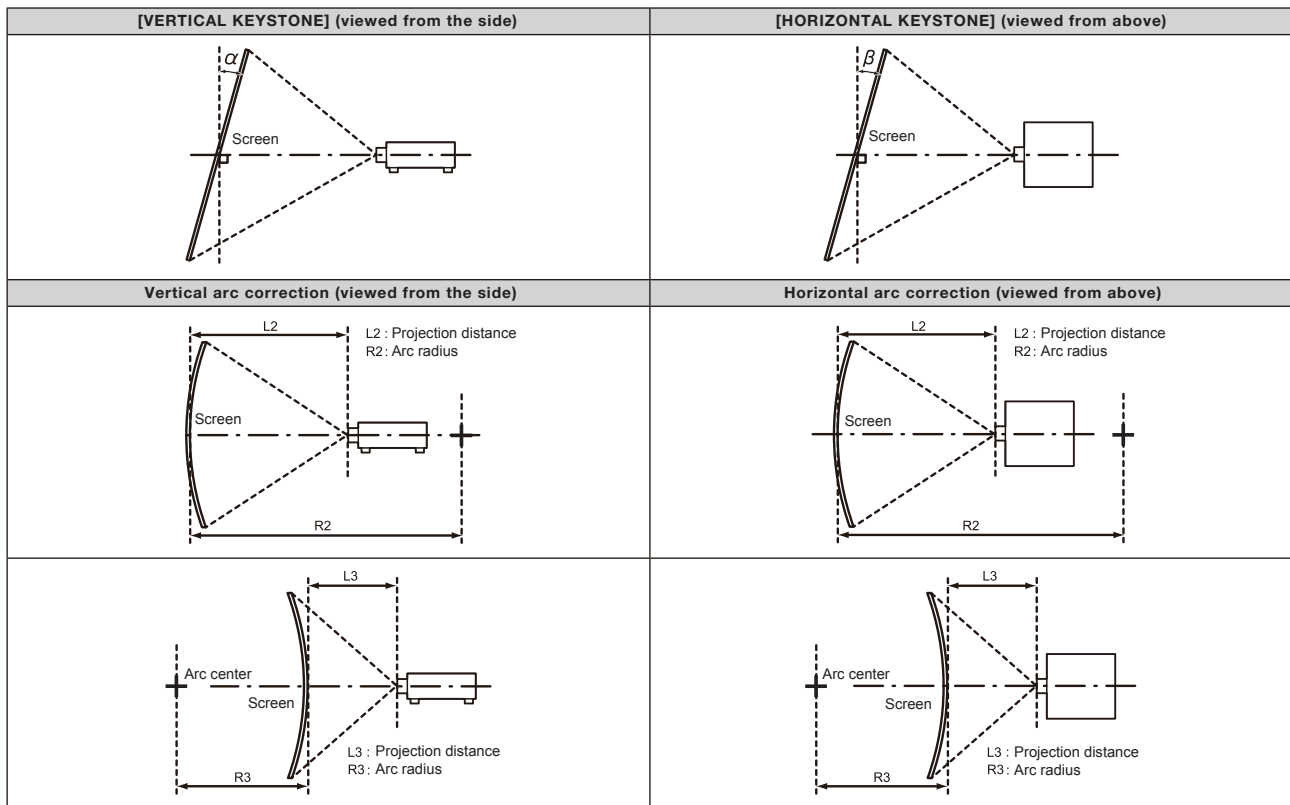

Standard status *Same when using the optional upgrade kit (ET-UK20)

Projector Model No.	Only [KEYSTONE] used		[KEYSTONE] and [CURVED CORRECTION] used together				Only [CURVED CORRECTION] used	
	Vertical keystone correction angle α (°)	Horizontal keystone correction angle β (°)	Vertical keystone correction angle α (°)	Horizontal keystone correction angle β (°)	Min. value of R2/L2	Min. value of 3/L3	Min. value of R2/L2	Min. value of R3/L3
PT-RCQ10/RCQ80/ RZ120/RZ970/ RW930/RX110/ RZ870/RZ770/ RW730/RZ660/ RW620	± 5	± 0	-	-	-	-	-	-