

DVI FHD Active Fiber Optical Cable

With detachable connectors

1080P
Full HD

100M
328ft

10.2
Gbps

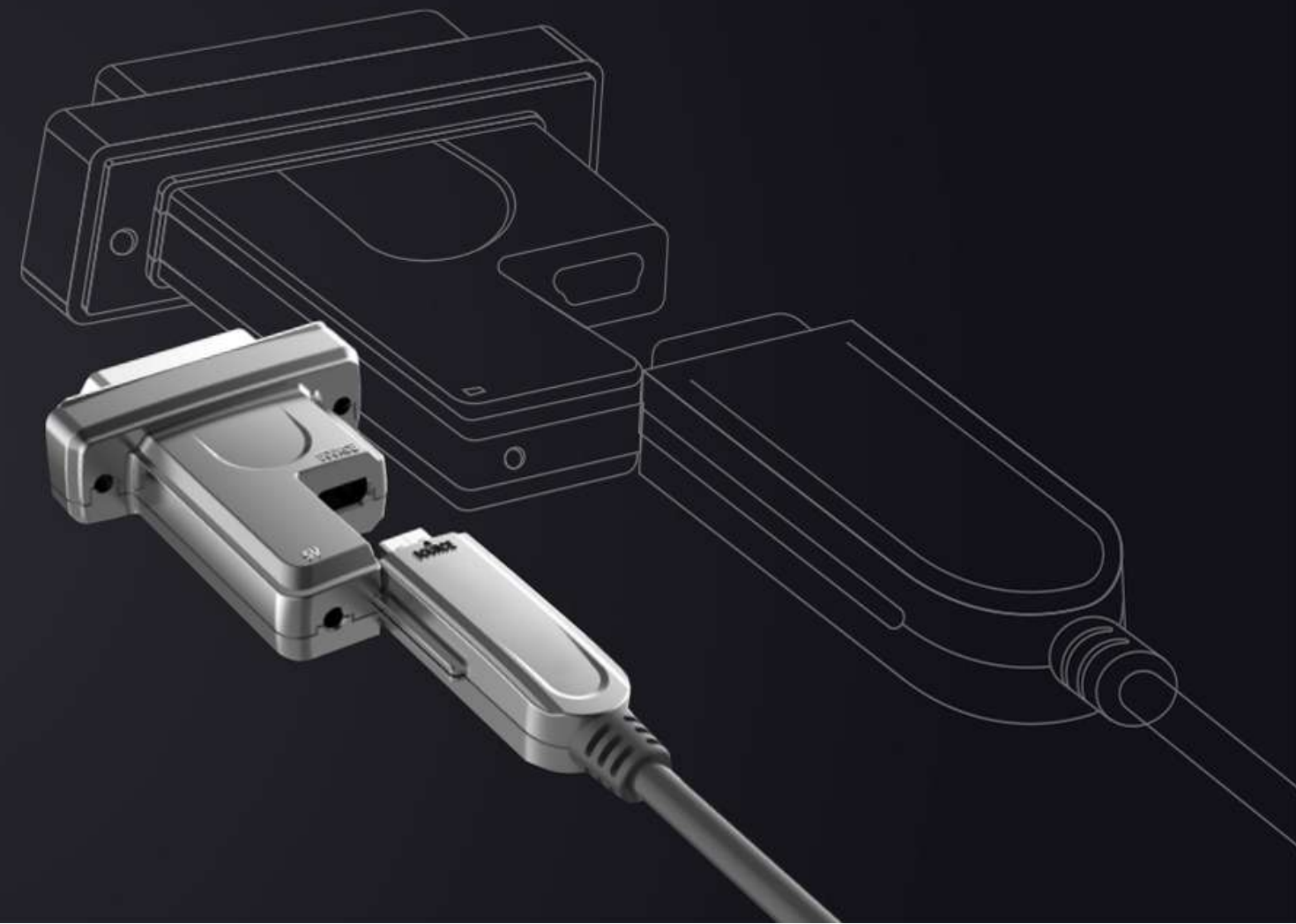

- DVI, 10.2Gbps, Active Optical Cable, HDMI type D to D with HDMI Type D to DVI detachable connectors;
- Max. 100m/ 328ft long distance, 1920 x 1080/60Hz 4:4:4;
- External power supply optional, supports 3D, HDCP 2.0, EDID;
- Hot swappable, plug & play;
- Order Code: AOC-DVI-Dxx

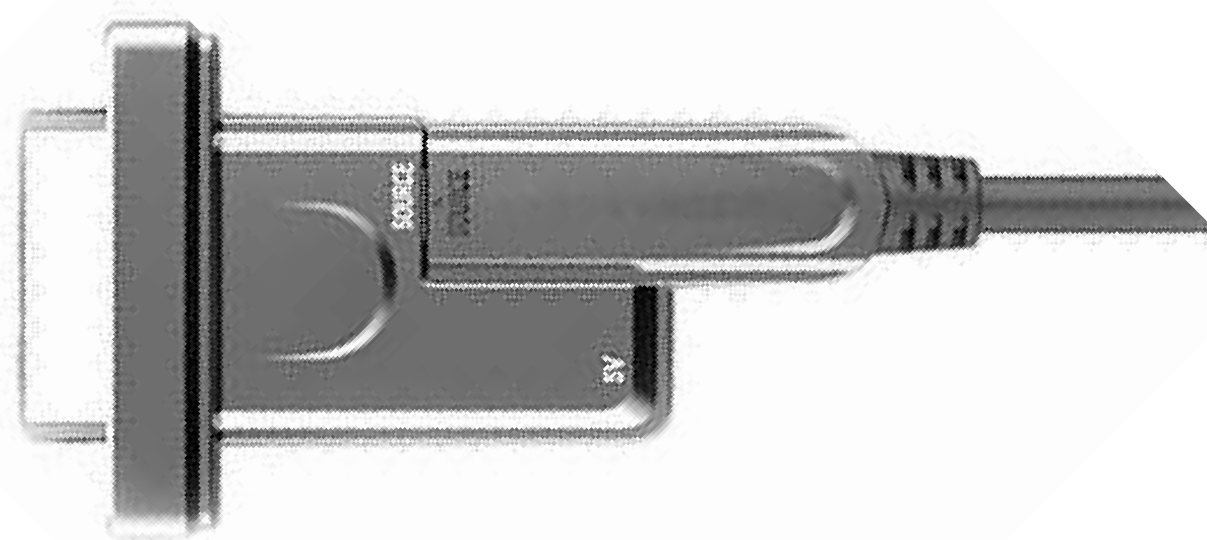



Long distance transmission

It supports 1080p FHD up to 100 meters or 328 feet without any signal loss and keep 100% EMI-free.



10.2Gbps Ultra High Bandwidth

 With bandwidth up to 10.2Gbps

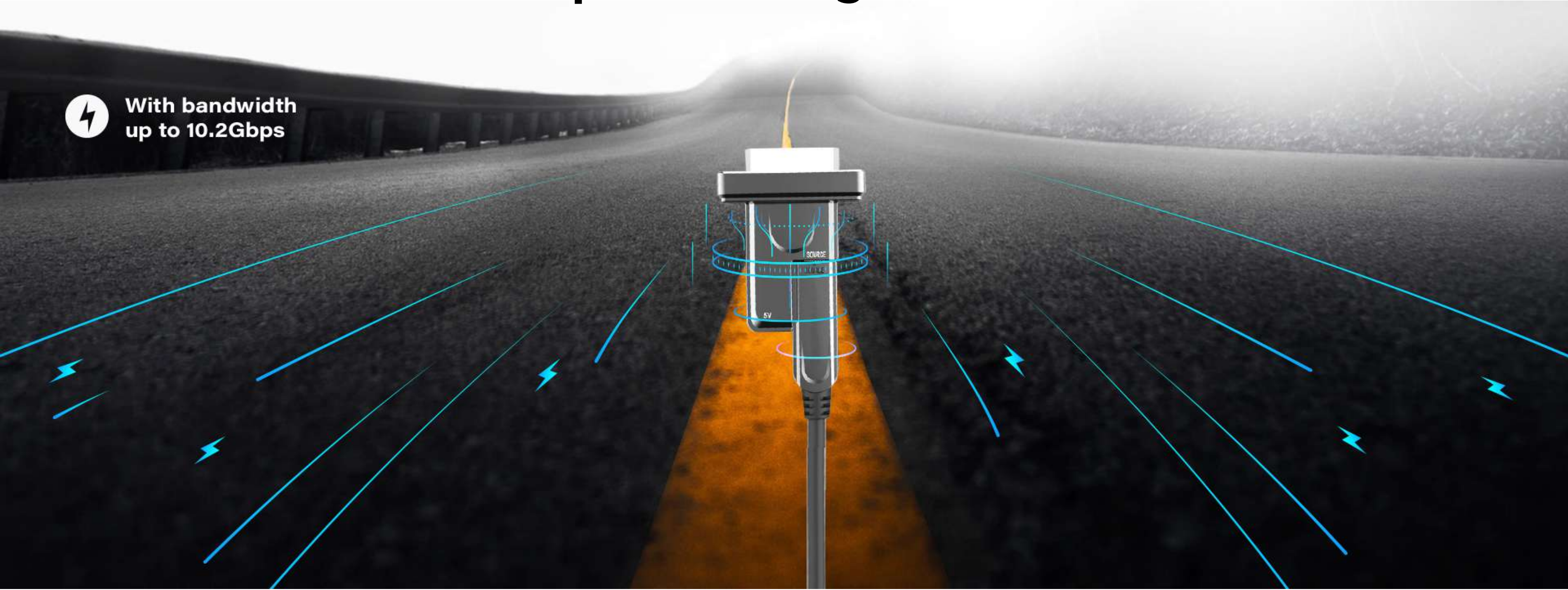

Plug and Play

It supports hot swappable, no software or driver needed.

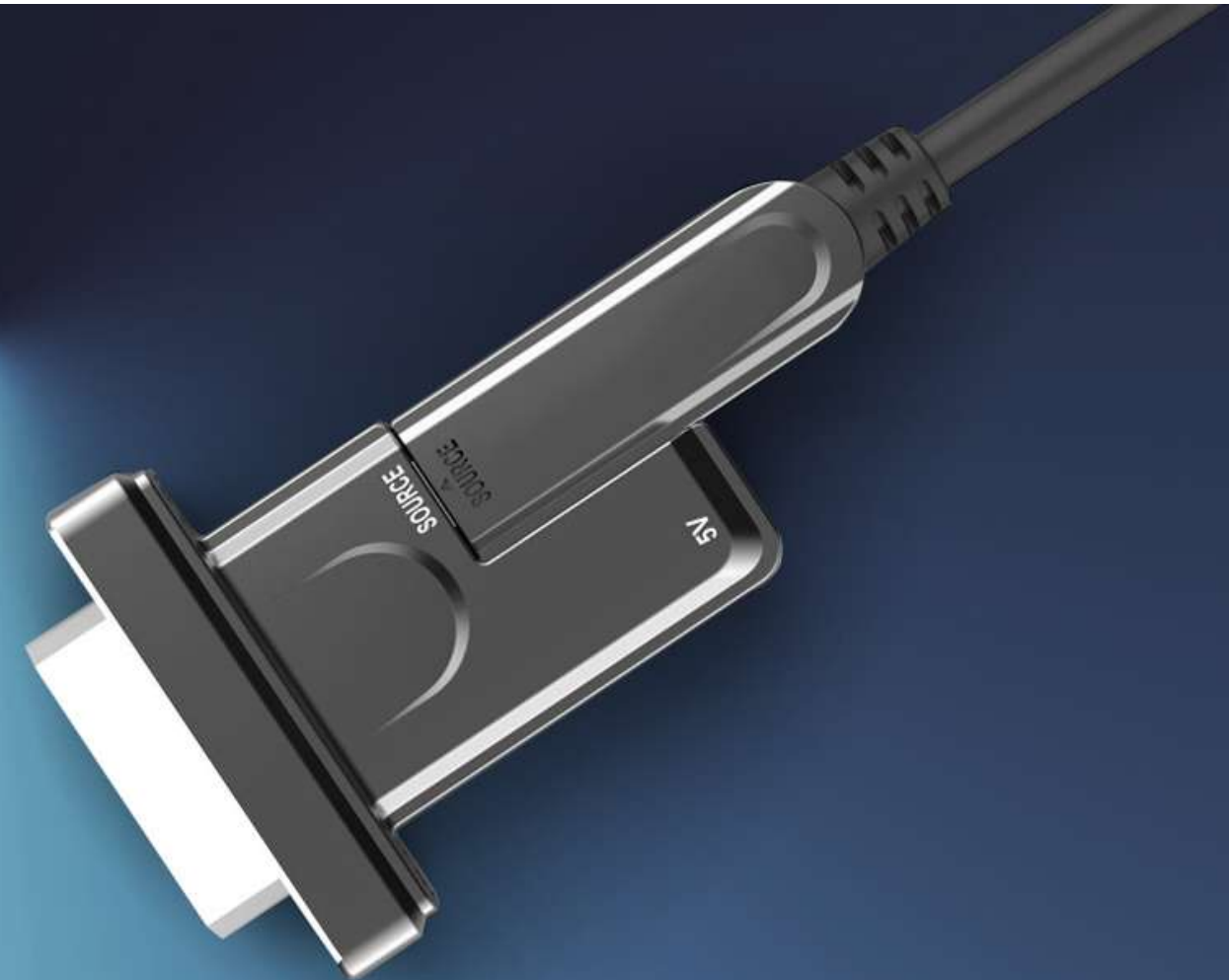

Save your labor cost

Thin, durable and pre-terminated HDMI type D connectors, which eliminate the need for time-consuming fiber terminations and the need for costly fiber optic tools. No additional extenders, baluns or amplifiers.



Thin construction

The sleek cable can be easily concealed or installed in the concealed locations, conduit, plenum spaces and cabling raceways



vs



Typical Copper cable

Active Fiber Optical Cable

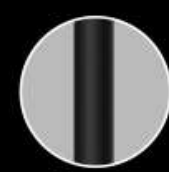

vs



Copper

AOC

Supports Stereo Audio

It supports PCM 8-channel, Dolby Digital True HD and DTS-HD Master Audio.



Lower consumption

100% EMI Free and max. 250mW lower consumption



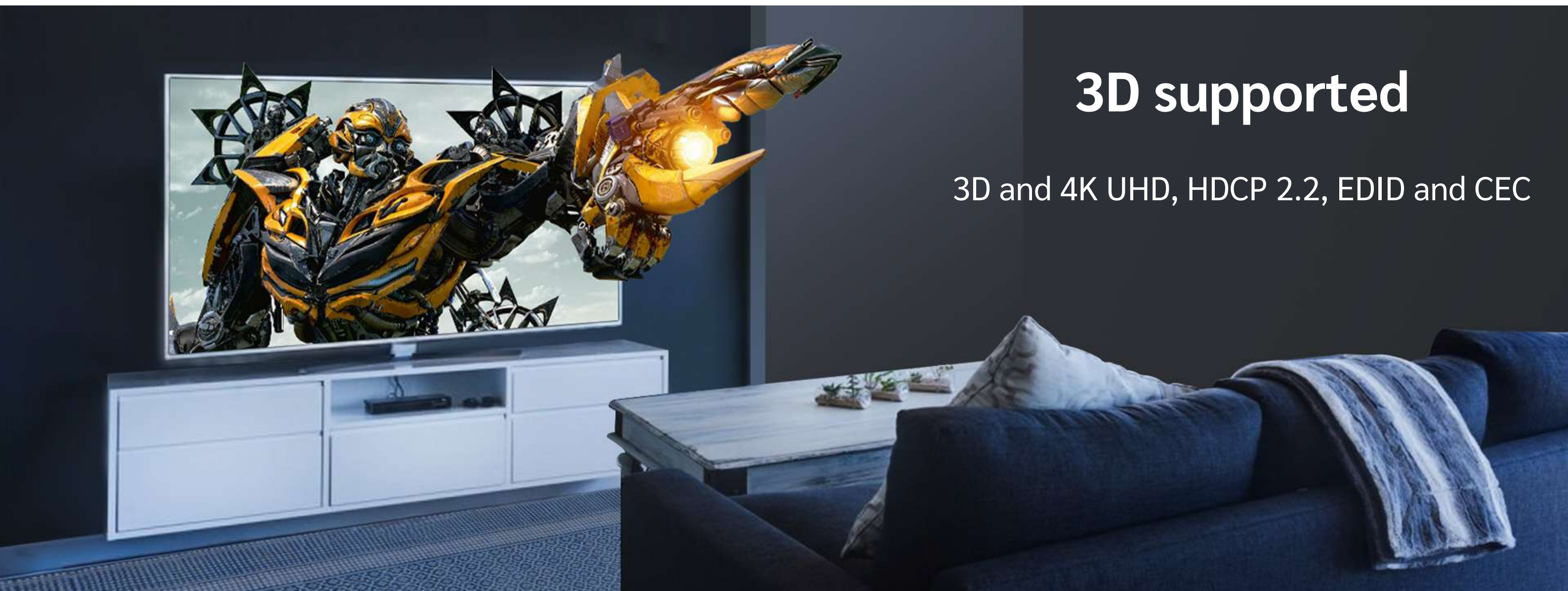

3D supported

3D and 4K UHD, HDCP 2.2, EDID and CEC

Specs



1920 x 1080/ 60Hz



High Bandwidth



100m Long distance



EMI free



Plug and play



No signal loss

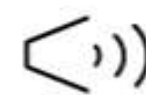

Stereo Audio

YES

EDID

Diagram

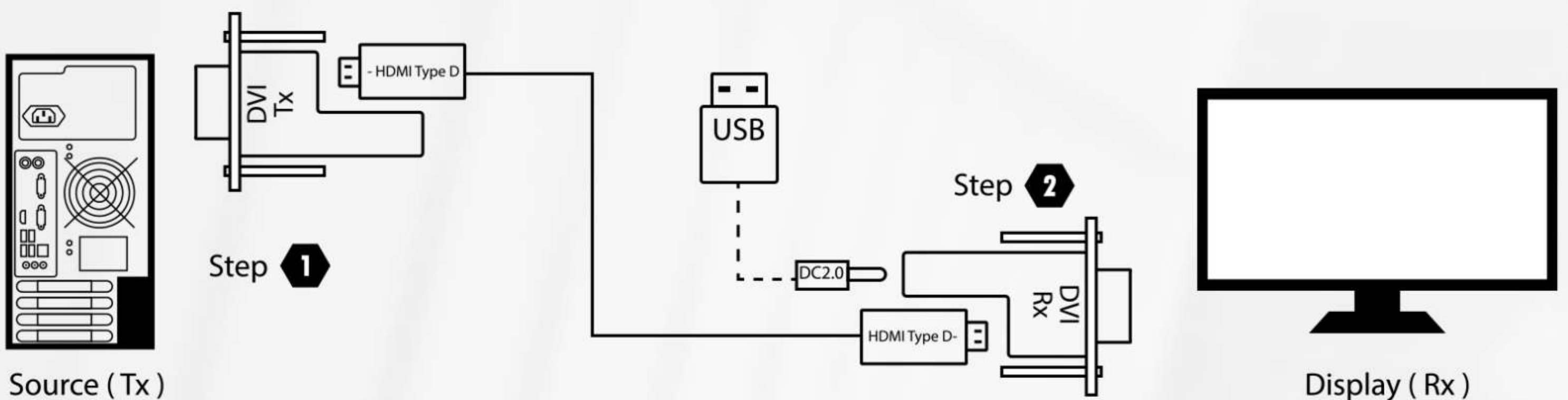

Datasheet

Feature/Spec	AOC-DVI-Dxx
Connector	HDMI Type D to DVI
Plug and Play	✓
Detachable	✓
Embedded power supply at Rx side	✓
External power supply	5V USB to DC 2.0
Hot swappable	✓
No software/ driver required	✓
Thin construction	✓
Max. Resolution	1080P/60Hz
HDCP compliant	✓
EDID	✓
CEC	X
100% EMI free	✓
Without signal loss	✓
Max Distance	100m/ 328ft
Power consumption	≤ 250mW
Bandwidth	10.2Gpbs
Stereo Audio	X
PCM 8-channel, Dolby Digital True HD and DTS-HD Master Audio.	X
Min. Bending Ratio	Dynamic 20D, Static 10D
Max. Compressed Stress	500N, 51Kg or
Max. Tensile Force	200N, 20Kg or
3D video	X
Fiber cable body dimension (Diameter)	4.2mm or 0.170"
Humidity	0-90% RH

Feature/Spec	AOC-HDMI-DxxC	AOC-HDMI-DxxP	AOC-HDMI-Fxx	AOC-DP-Dxx	AOC-DP-Fxx	AOC-DVI-Dxx
Connector	HDMI Type D to D	HDMI Type D to D	HDMI Type A	Mini DP to DP	DP	HDMI Type D to DVI
Plug and Play	✓	✓	✓	✓	✓	✓
Detachable	✓	✓	X	✓	X	✓
Embedded power supply at Rx side	✓	✓	✓	✓	✓	✓
External power supply	5V USB to DC 2.0	X	X	5V Micro USB	X	5V USB to DC 2.0
Hot swappable	✓	✓	✓	✓	✓	✓
No software/ driver required	✓	✓	✓	✓	✓	✓
Thin construction	✓	✓	✓	✓	✓	✓
Max. Resolution	4K/30Hz/ 60Hz 4:4:4	4K/30Hz/ 60Hz 4:4:4	4K/30Hz/ 60Hz 4:4:4	4K/120Hz, 8K/60Hz	4K/120Hz, 8K/60Hz	1080P/60Hz
HDCP compliant	✓	✓	✓	✓	✓	✓
EDID	✓	✓	✓	✓	✓	✓
CEC	✓	✓	✓	✓	✓	X
100% EMI free	✓	✓	✓	✓	✓	✓
Without signal loss	✓	✓	✓	✓	✓	✓
Max Distance	100m/ 328ft	300m/ 984ft	100m/ 328ft	100m/ 328ft	100m/ 328ft	100m/ 328ft
Power consumption	≤ 250mW	≤ 250mW	≤ 250mW	≤ 250mW	≤ 250mW	≤ 250mW
Bandwidth	18Gpbs	18Gpbs	18Gpbs	32.4Gpbs	32.4Gpbs	10.2Gpbs
Stereo Audio	✓	✓	✓	✓	✓	X
PCM 8-channel, Dolby Digital True HD and DTS-HD Master Audio.	✓	✓	✓	✓	✓	X
Min. Bending Ratio	Dynamic 20D, Static 10D	Dynamic 20D, Static 10D	Dynamic 20D, Static 10D	Dynamic 20D, Static 10D	Dynamic 20D, Static 10D	Dynamic 20D, Static 10D
Max. Compressed Stress	500N, 51Kg or 112lbs	500N, 51Kg or 112lbs	500N, 51Kg or 112lbs	500N, 51Kg or 112lbs	500N, 51Kg or 112lbs	500N, 51Kg or 112lbs
Max. Tensile Force	200N, 20Kg or 44lbs	200N, 20Kg or 44lbs	200N, 20Kg or 44lbs	200N, 20Kg or 44lbs	200N, 20Kg or 44lbs	200N, 20Kg or 44lbs
3D video	✓	✓	✓	✓	✓	X
Fiber cable body dimension (Diameter)	4.2mm or 0.170"	4.2mm or 0.170"	4.2mm or 0.170"	4.2mm or 0.170"	4.2mm or 0.170"	4.2mm or 0.170"
Humidity	0-90% RH	0-90% RH	0-90% RH	0-90% RH	0-90% RH	0-90% RH



 www.osf-av.com

 commercial@osf-av.fr

 01 85 11 06 65

