

VWM2157

MENU BOARD WALL MOUNT

MODULAR 2X1, FOR 50"-57" SCREENS

VWM2157 is a robust and accurately manufactured menu board wall mount for two 50"-57" screens mounted in landscape orientation. The mount is designed for quick and easy video wall expansion. Thanks to the modular concept, any configuration of the video wall can be arranged. The micro-adjustment system allows you to adjust the position of the screen very precisely and adjust it to the other monitors. The integrated cable management system allows the cabling to be hidden, guaranteeing aesthetic appearance. VWM2157 is perfect for public areas and restaurants, wherever there is a need for frequent layout changes and dynamic communication with the audience.

FEATURES

- Quick and simple installation
- For mounting 2 x 50"-57" screens
- Possibility of tilting the screen by 11°
- Durable aluminum structure
- Patented beam level adjustment system
- Universal VESA-compliant mounting range
- Possibility of easy extension with additional modules

PRODUCT SPECIFICATIONS

Short index	VWM2157
Category	Menu Board Wall Mounts
Product group	Video Wall & Menu Board Mounts
Colour	Black
Warranty	Limited 5-years
Number of screens	2
Minimum screen size	50"
Maximum screen size	57"
Maximum load	160 kg
Forward tilting	+11°
VESA Mounting Compatibility	50x50 do 600x400

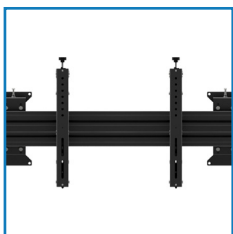
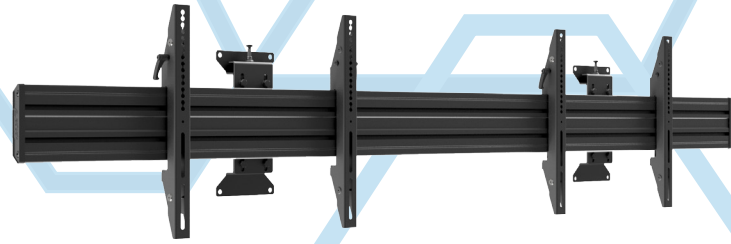

For mounting 2 x 50"-57" screens

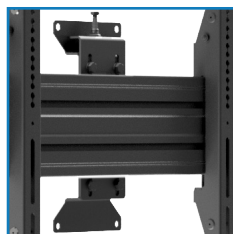

Possibility of tilting the screen by 11°



Universal VESA-compliant mounting range

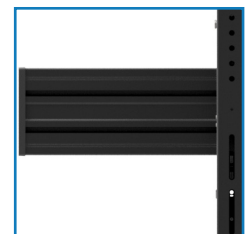

Possibility of easy extension with additional modules

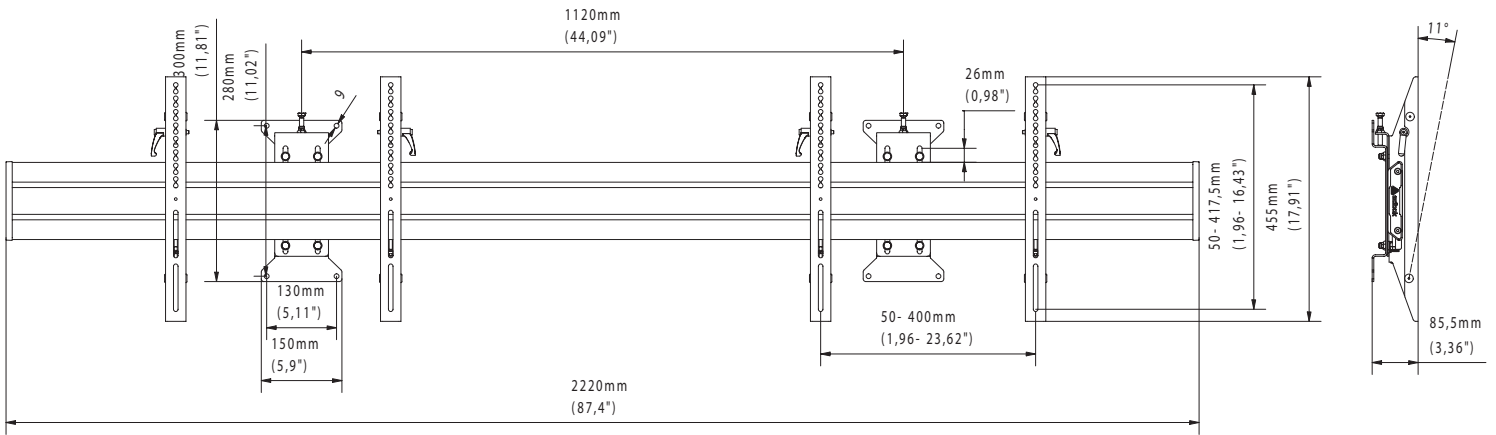
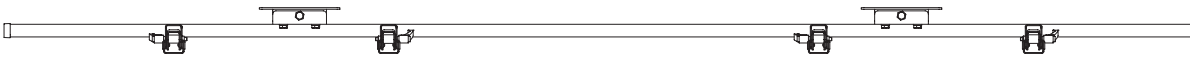
FRONT VIEW
SIDE VIEW

TOP VIEW

TECHNICAL SPECIFICATIONS

Product dimensions	W: 85,5 mm D: 2220 mm H: 455 mm (W: 3,37" D: 87,40" H: 17,91")
Product weight	14,5 kg (32 lb)
Max. distance from mounting surface	
Min. distance from mounting surface	
Max. mounting pattern	600 mm x 417,5 mm
Min. mounting pattern	50 mm x 50 mm

LOGISTICS DATA

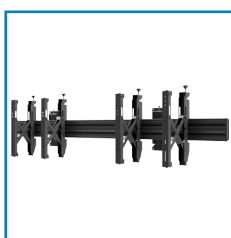
SAP INDEKS	EAN CODE	COLOUR	PACKAGE DIMENSIONS	PACKAGE WEIGHT
WUSC-VWM2157	5902841136632	BLACK	750 x 550 x 70 mm 29,53 x 21,65 x 2,76"	16 kg (35 lb)

HS Code (Harmonized System): 732690, HTS Code (Harmonized Tariff Schedule): 7326909890, Country of Origin: Poland

ACCESSORIES AND RELATED PRODUCTS

VWM2157POP



MBV2147-L

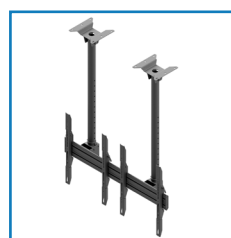

MBV2147-P



MBV2155-L